

## T7460A,B,C,D,E,F WALL MODULES



### INSTALLATION INSTRUCTIONS

#### BEFORE INSTALLATION

All wiring must comply with local electrical codes and ordinances or as specified on installation wiring diagrams.

Wall module wiring can be sized from 16 to 22 AWG (1.5 to 0.34 mm<sup>2</sup>), depending on the application. The maximum length of wire from a device to a wall module is 1000 ft (305 m). Twisted-pair wire is recommended for wire runs longer than 100 ft (30.5 m).

#### COVER DISASSEMBLY

The cover of the wall module is fixed in place using a tab located on the underside of the unit; to disassemble the cover and the subbase, see Fig. 1.

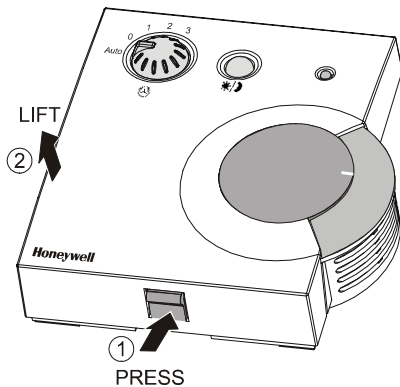

Fig. 1. Cover disassembly.

Table 1. Features of T7460 Versions

	Sensor	Setpoint	Bypass/ LED	Fan speed
T7460A	✓	-	-	-
T7460B	✓	✓	-	-
T7460C	✓	✓	✓	-
T7460D	✓	✓	-	5-position
T7460E	✓	✓	✓	3-position
T7460F	✓	✓	✓	5-position

#### INSTALLATION

The T7460B,C,D,E,F packages include two setpoint dials. By default, the "Celsius Relative" type is mounted. This can be easily replaced with the "Celsius Absolute" type by pulling the one dial off and inserting the other one.

Mount the T7460A,B,C,D,E,F Wall Modules on an inside wall approximately 54 in. (1.3 m) from the floor (or in the specified location) to allow exposure to the average zone temperature.

**NOTE:** Maintain a mounting clearance of approx. 4 in. (10 cm) to the left-hand side of the module in order to allow a free airflow for the temperature sensor and accessibility of the setpoint dial.

Do not mount the wall modules on an outside wall, on a wall containing water pipes, or near air ducts. Avoid locations that are exposed to discharge air from registers or radiation from lights, appliances, or the sun.

The T7460D,E,F should not be connected to controllers that do not support fan operation (e.g. W7751, W7762, W7763).

Keep wiring at least one ft (305 mm) away from large inductive loads such as motors, line starters, lighting ballasts, and large power distribution panels.

Run wall module wiring separately from 50 Vac or greater power wiring.

The wall modules can be mounted on a 60-mm wall outlet box using No. 6 (3.5-mm) screws or on a wall (see Fig. 2 and 5). When mounting directly on a wall, use the type of screws appropriate for the wall material.

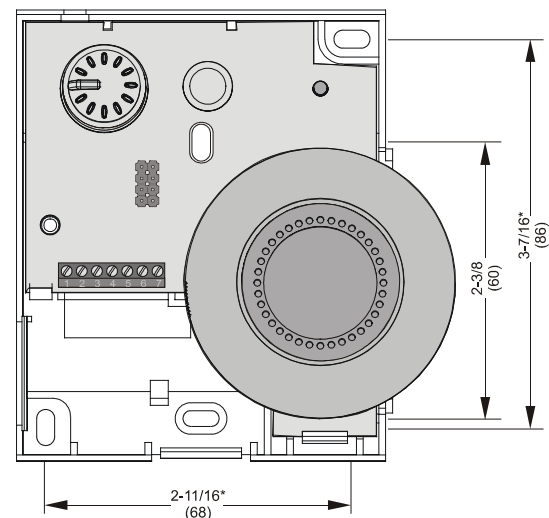

\* bore-hole dimensions for optional wall mounting

Fig. 2. Bore-holes for T7460 wall modules in in. (mm).

See Fig. 3 for T7460A,B,C,D,E,F mounting dimensions.

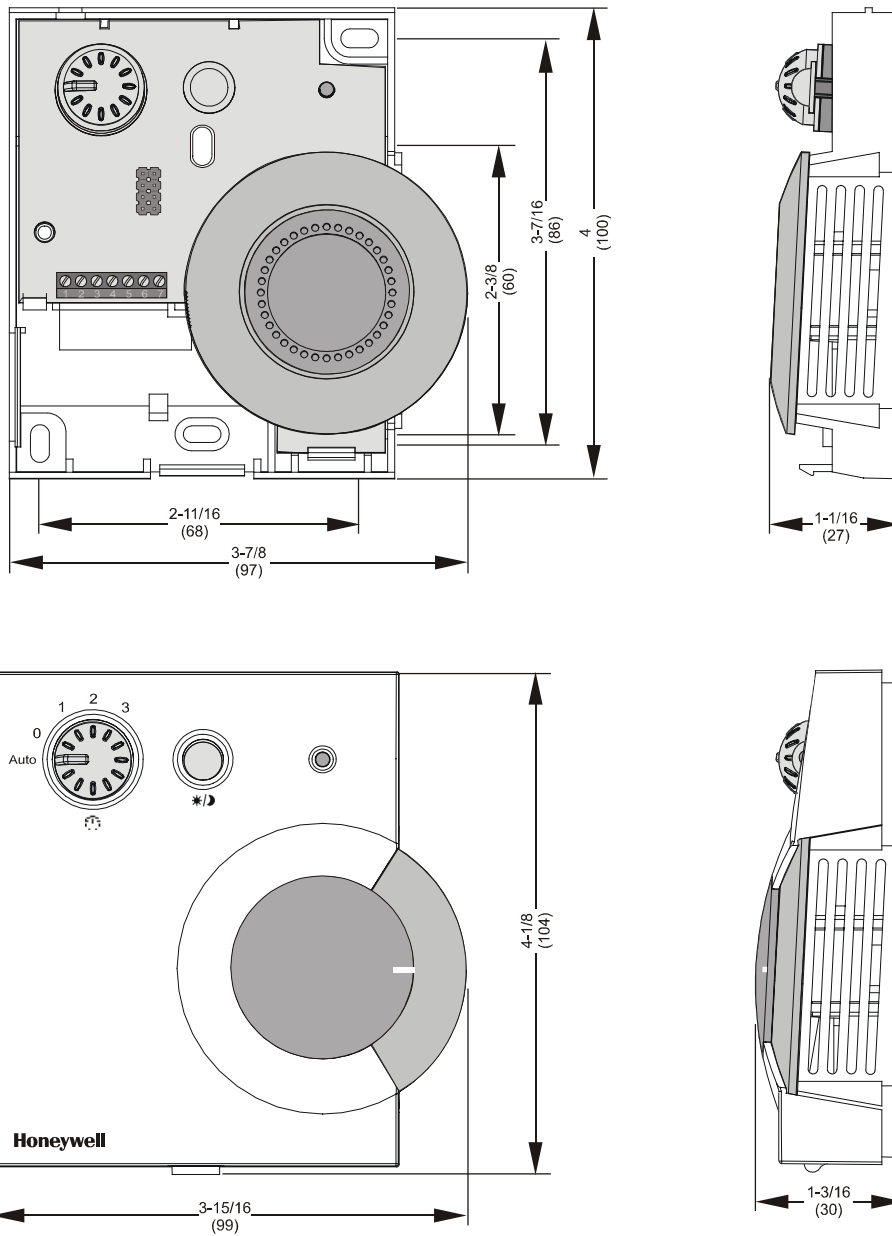

**NOTE:** Graphics show E/F model. Dimensions are the same for all six models.

**Fig. 3. T7460A,B,C,D,E,F dimensions in in. (mm).**

## Mounting Procedure

1. Disassemble the cover as is shown in Fig. 1.
2. (T7460B,C,D,E,F only)  
Remove the setpoint dial by pulling it off.
3. a) Mount the wall module onto the wall outlet box,  
or  
b) bore wall holes as is specified in Fig. 2 and  
mount the wall module with appropriate screws.
4. Connect the wires to the terminal block according  
to the specifications in the "Wiring" section.
5. (T7460B,C,D,E,F only)  
Insert the setpoint dial and turn it clockwise as far  
as possible.
1. (T7460B,C,D,E,F only)  
Make sure that the dial's position is such that the  
30 (Celsius absolute scale) or the +5 (Celsius  
relative scale) point to the right-hand side of the  
wall module (see Fig. 4).

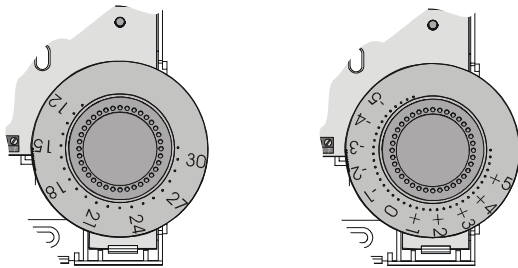

Fig. 4. Mounting position of setpoint dial.

7. (T7460B,C,D,E,F only)  
If the dial does not have the correct position, pull  
the dial off again and reinsert it with the correct  
orientation.
8. Remount the cover as depicted in Fig. 5 and make  
sure that the tab on the underside engages.

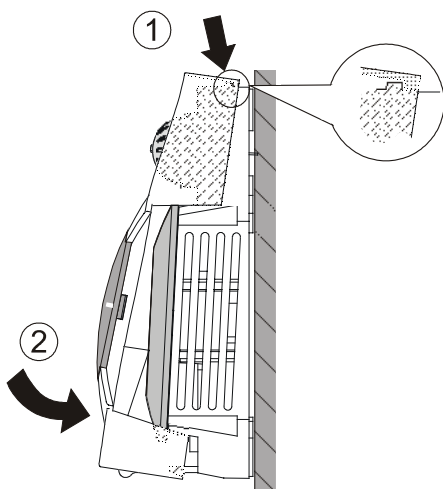

Fig. 5. Mounting cover of T7460 wall modules.

## Wiring

Attach the wires from the device sensor terminals to the appropriate wall module terminals and set the jumpers according to the connected controller. See Fig. 6, 7 and 8.

**NOTE:** Not all of the T7460 wall modules are compatible with W7751A,C,E,G(VAV1) and W7752D1(FCU1) Controllers.

### IMPORTANT

Screw type terminal blocks are designed to accept no more than one 16 AWG (1.5 mm<sup>2</sup>) conductor.

Wire the terminal blocks as follows:

1. Strip 3/16 in. (5 mm) of insulation from the conductor.
2. Insert the wire in the required terminal location and tighten the screw to complete the termination.
3. Verify jumper setting with Fig. 6 and wall module wiring with Fig. 7 and 8.

## Jumper settings

According to the type of controller connected, the following jumpers have to be set on the PCB of the T7460C,D,E,F.

**NOTE:** The "W77xx" at the first jumper position stands for the Excel 10 and Excel 12 controllers:

Const. Vol. Air Handling Unit	W7750A,B
(Smart) Variable Air Volume	W7751B,D,F,H
Fan Coil Unit (FCU2)	W7752D,E,F,G
Remote Input/Output Device	W7761A
Hydronic	W7762A,B
Chilled Ceiling	W7763C,D,E
Excel 12	W7704xx

**Excel 10 Controller:  
W7750, W7751, W7752  
W7761, W7762, W7763**

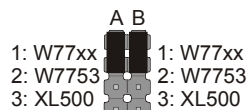

Factory Default

**Excel 10 Controller:  
W7753A (Unit Ventilator)**

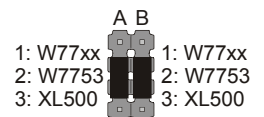

**Excel Controller:  
20, 50, 80, 100, 500, 600  
without fan**

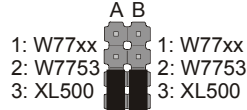

**Excel Controller:  
20, 50, 80, 100, 500, 600  
with fan**

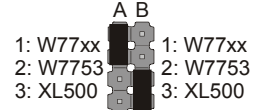
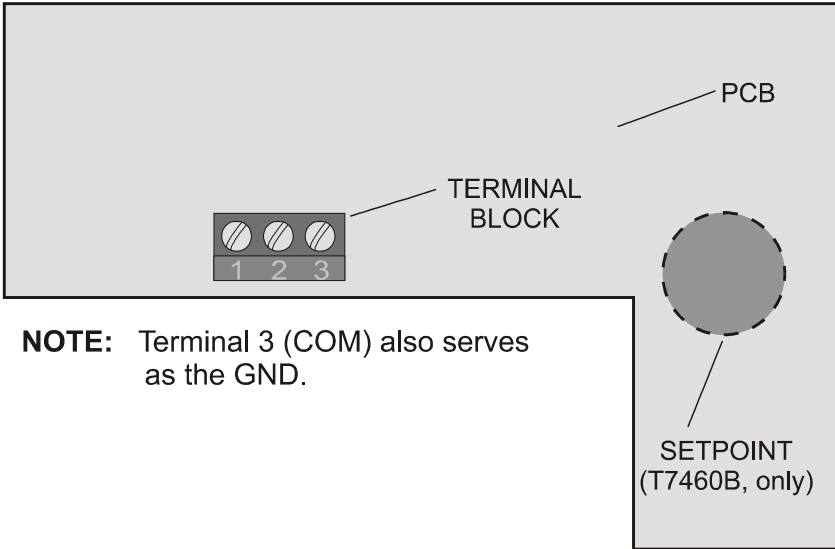

Fig. 6. Jumper settings for T7460C,D,E,F Wall Modules.



**IMPORTANT:**

The gray/shaded terminals are internally connected. The white/unshaded terminals are not internally connected.

**Wiring of Modules:**

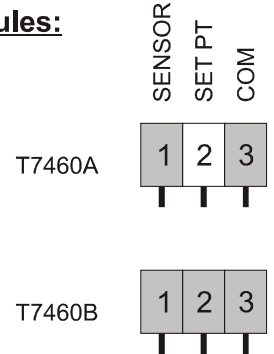
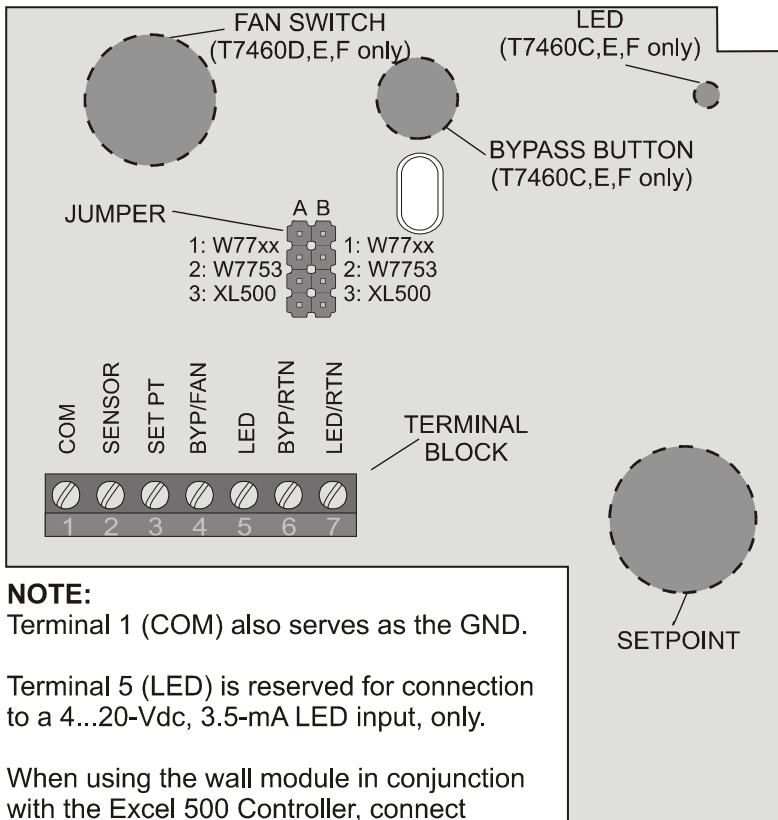

Fig 7. Wiring diagram for T7460A,B Wall Modules.



**IMPORTANT:**

The gray/shaded terminals are internally connected. The white/unshaded terminals are not internally connected.

**Wiring of Modules:**

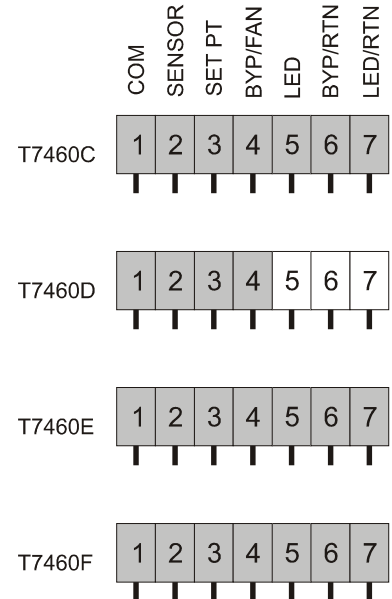

Fig 8. Wiring diagram for T7460C,D,E,F Wall Modules (for the jumper settings, see Fig. 6).

## ACCESSORIES

### T7460-LONJACK

The T7460-LONJACK allows to easily access LONWORKS via the wall module. LONWORKS will be connected to the two LON terminals. A PC connection can be established using the 3.5-mm jack plug.

Order quantity: set with 5 pieces

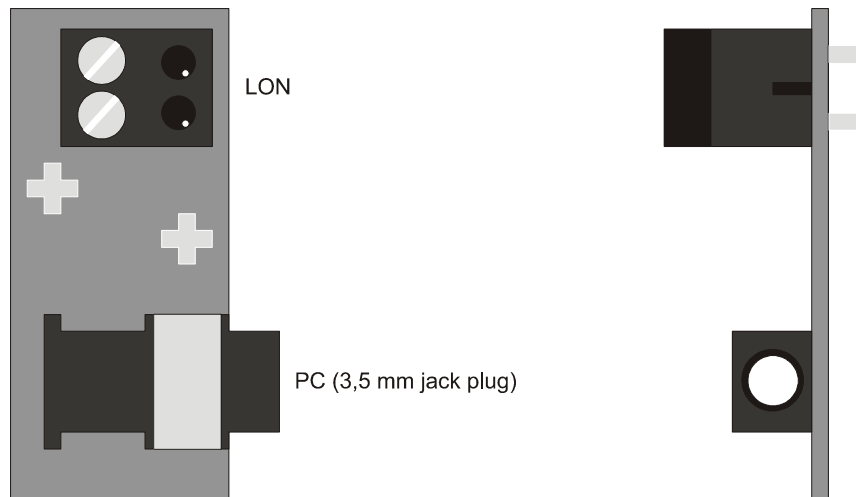

Fig 9. T7460-LONJACK

### Mounting

Remove the setpoint dial and put in the T7460-LONJACK as shown in the following:

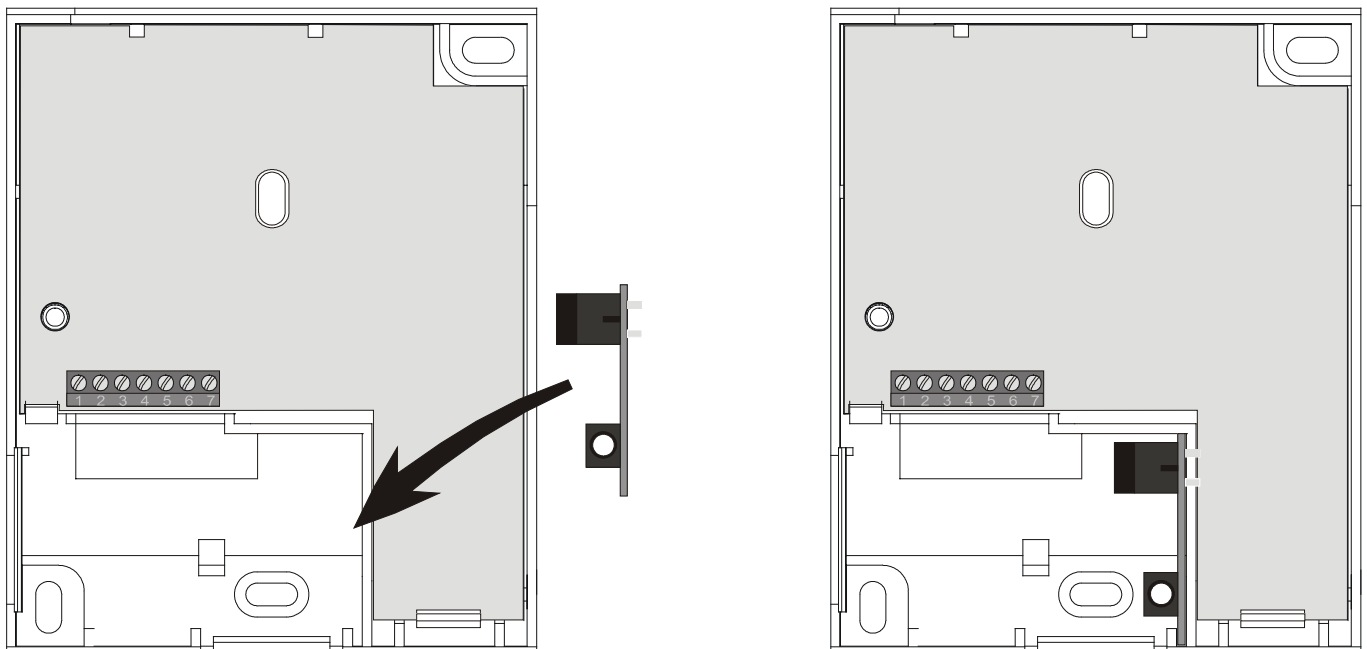

Fig 10. Mounting T7460-LONJACK

## T7460-LIMITER

The T7460-LIMITER can be used to adjust the setpoint dial to particular setpoints.

Put the limiters approximately opposite the setpoints you want to adjust. In the following example, the setpoints are at about 18 and 27 °C.

Order quantity: set of 100 pieces

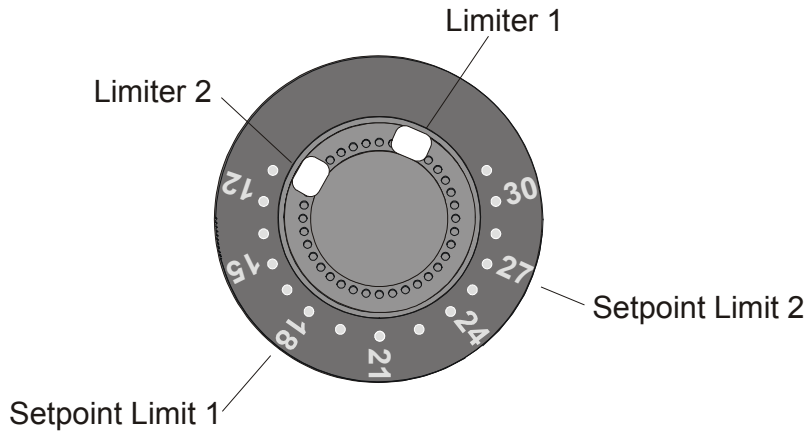

Fig 11. Mounting T7460-LIMITER(S)

---

**Honeywell**

**Home and Building Control**  
Honeywell Inc.  
Honeywell Plaza  
P.O. Box 524  
Minneapolis, MN 55408-0524  
USA  
<http://www.honeywell.com>

**Home and Building Control**  
Honeywell Limited-Honeywell Limitee  
155 Gordon Baker Road  
North York, Ontario  
M2H 3N7  
Canada  
<http://www.honeywell.ca>

**Home and Building Control Products**  
Honeywell AG  
Böblinger Straße 17  
D-71101 Schönaich  
Germany  
<http://europe.hbc.honeywell.com>

DIN EN ISO  
9001/14001